

FORTISSIMO

Tehnički katalog

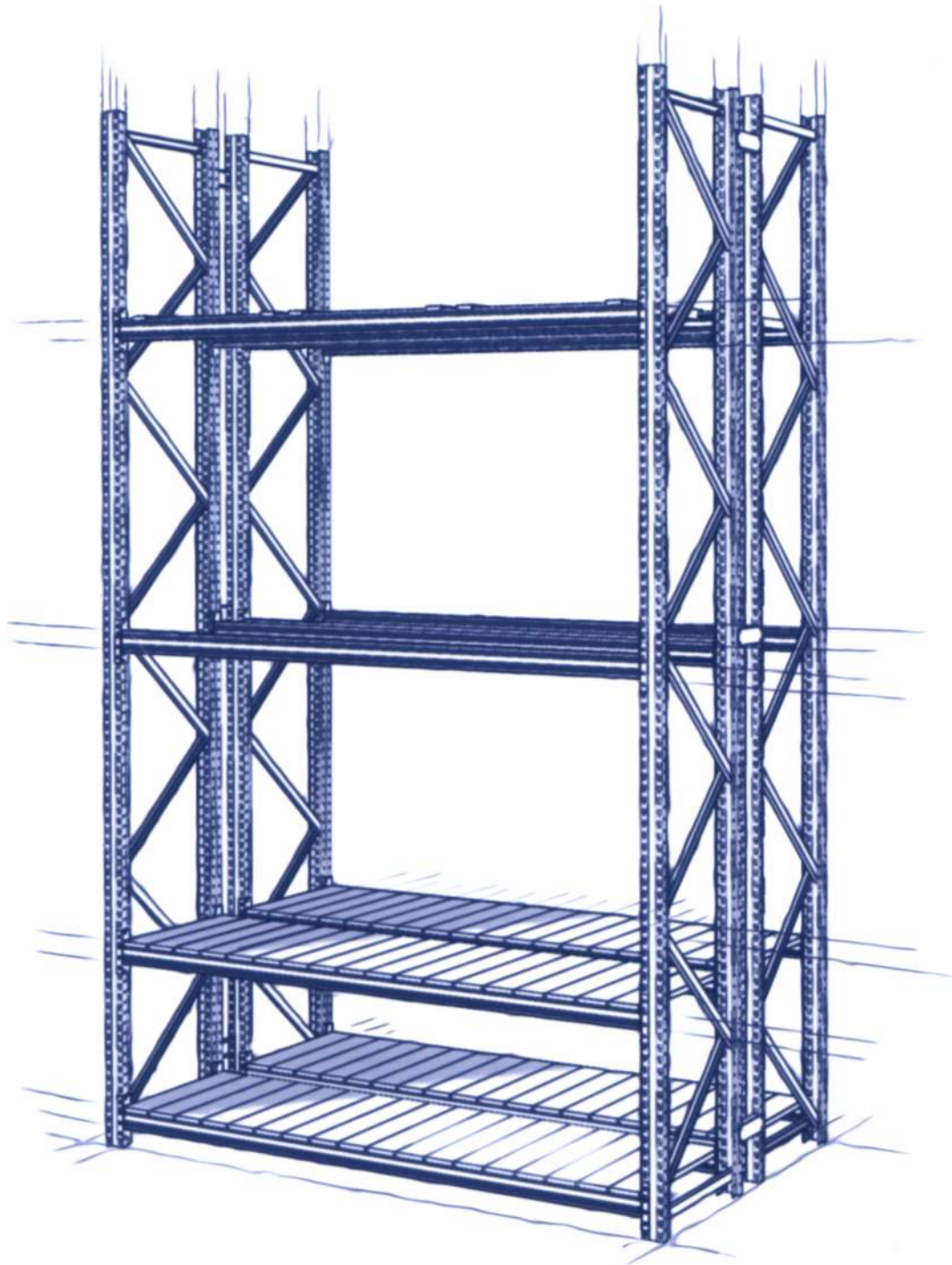

ELEMENTI

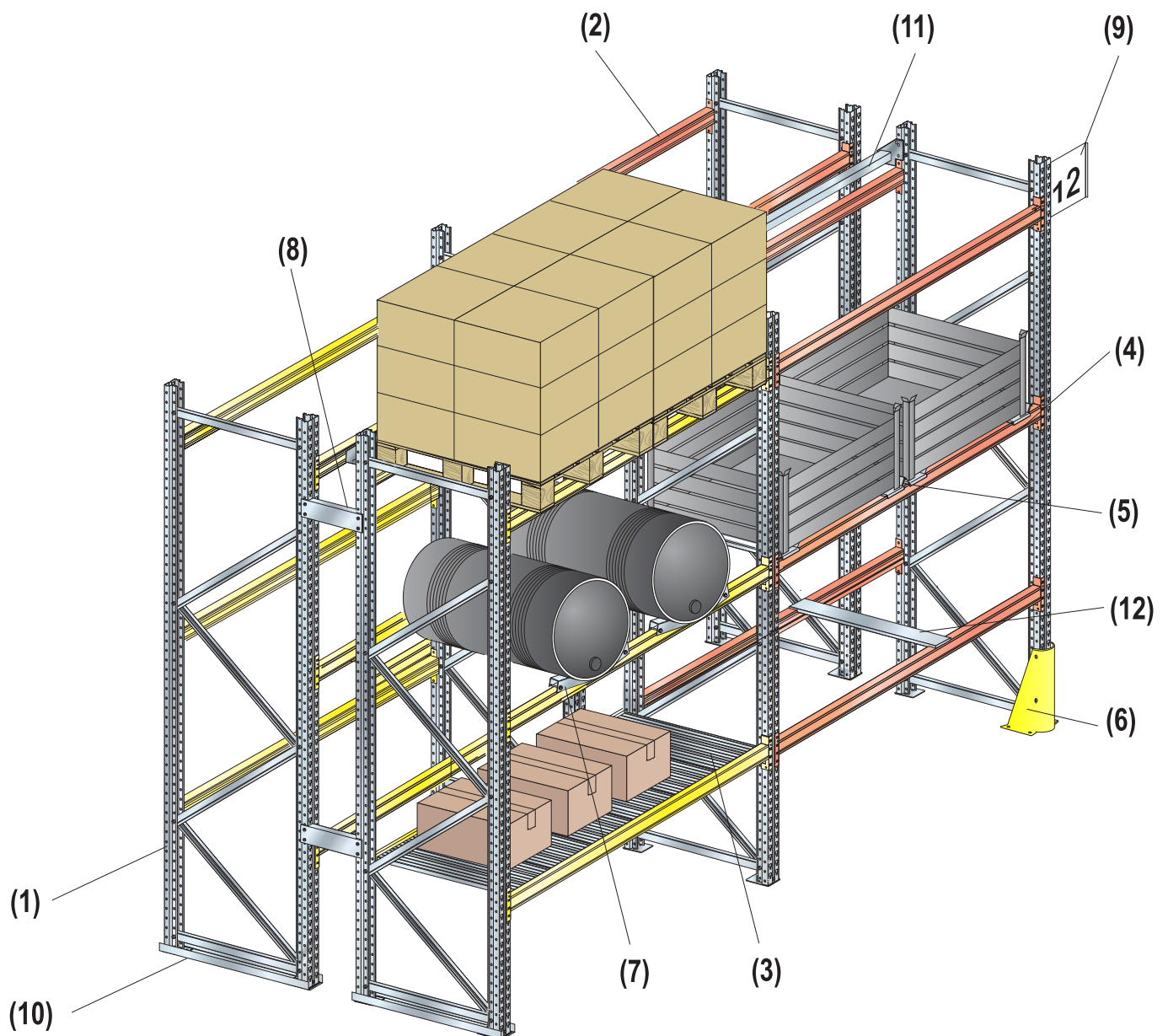

1). - BOČNA STRANA

2). - PAR GREDA

3). - POCINČANE ISPUNE

4). - DRŽAČ KONTEJNERA

5). - DRŽAČ KONTEJNERA

6). - ŠTITNIK STUPA

7). - DRŽAČ BAČVI

8). - VEZA STUP - STUP

9). - INFORMACIJA OPTEREČENJA

10). - RAZDJELJIVAČ OPTEREČENJA

11).- GRANIČNIK PALETE

12).- POPREČNI NOSAČ

BOČNE STRANE

STANDARDNE ŠIRINE I VISINE

SERIJA L50

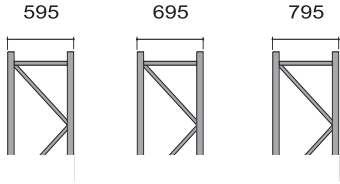

SERIJA L50 JE PREDVIĐENA U KOMBINACIJI S POLICAMA ILI DRVENIM ISPUNAMA DUBINA 500, 600 I 700 mm, NA GREDAMA DUŽINE 900 - 2630 mm I NOSIVOSTIMA 450 DO 3000 Kg PO PARU GREDA / POLICA

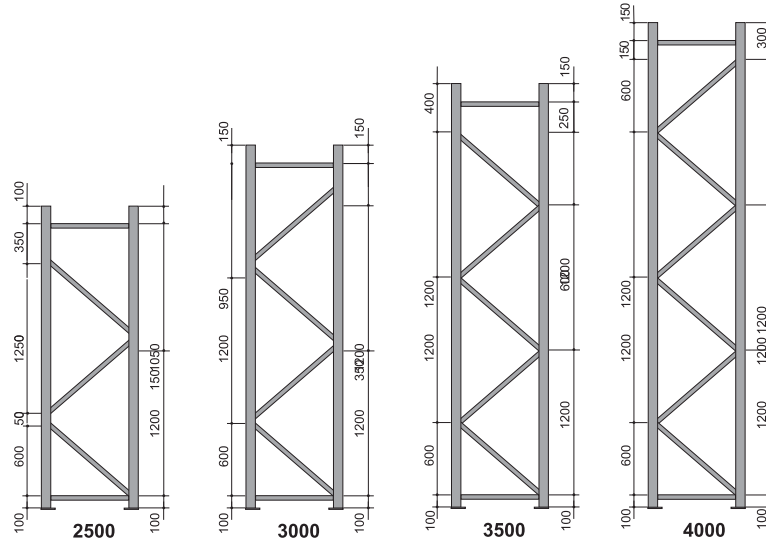

SERIJE L80, L100 I L120

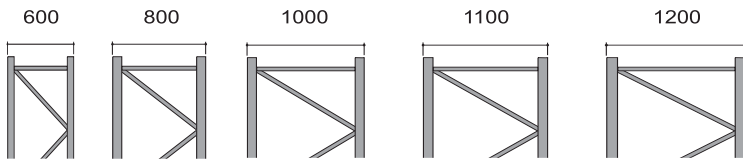

SERIJE L80 L100 I L120 JE STANDARDNA BOČNA STRANA DUBINA OD 600 - 1200 mm ZA KONSTRUKCIJU PALETNIH REGALA A IZBOR OVISI O TEŽINI PALETA NA GREDAMA DUŽINA 1200 - 3600 mm I NOSIVOSTIMA 800 DO 10200 Kg PO PARU GREDA

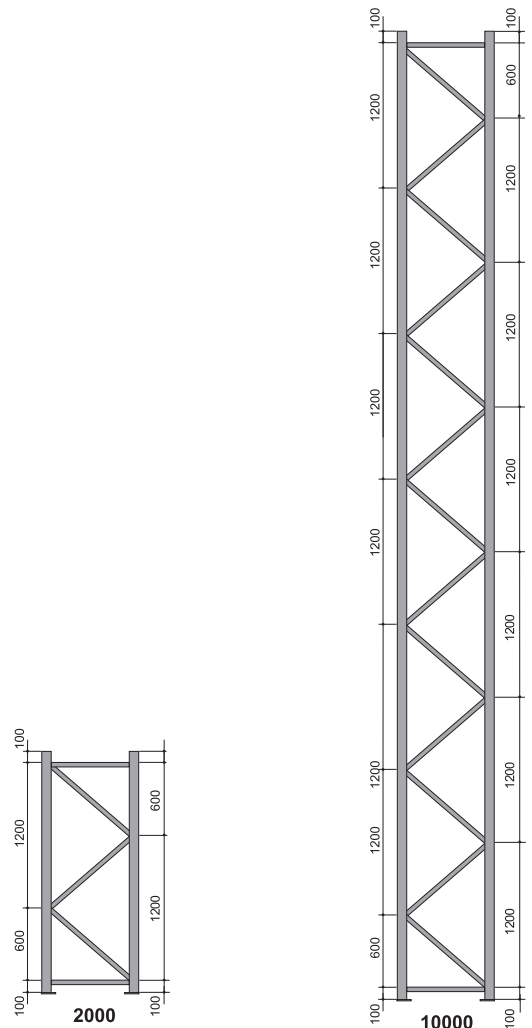

BOČNE STRANE

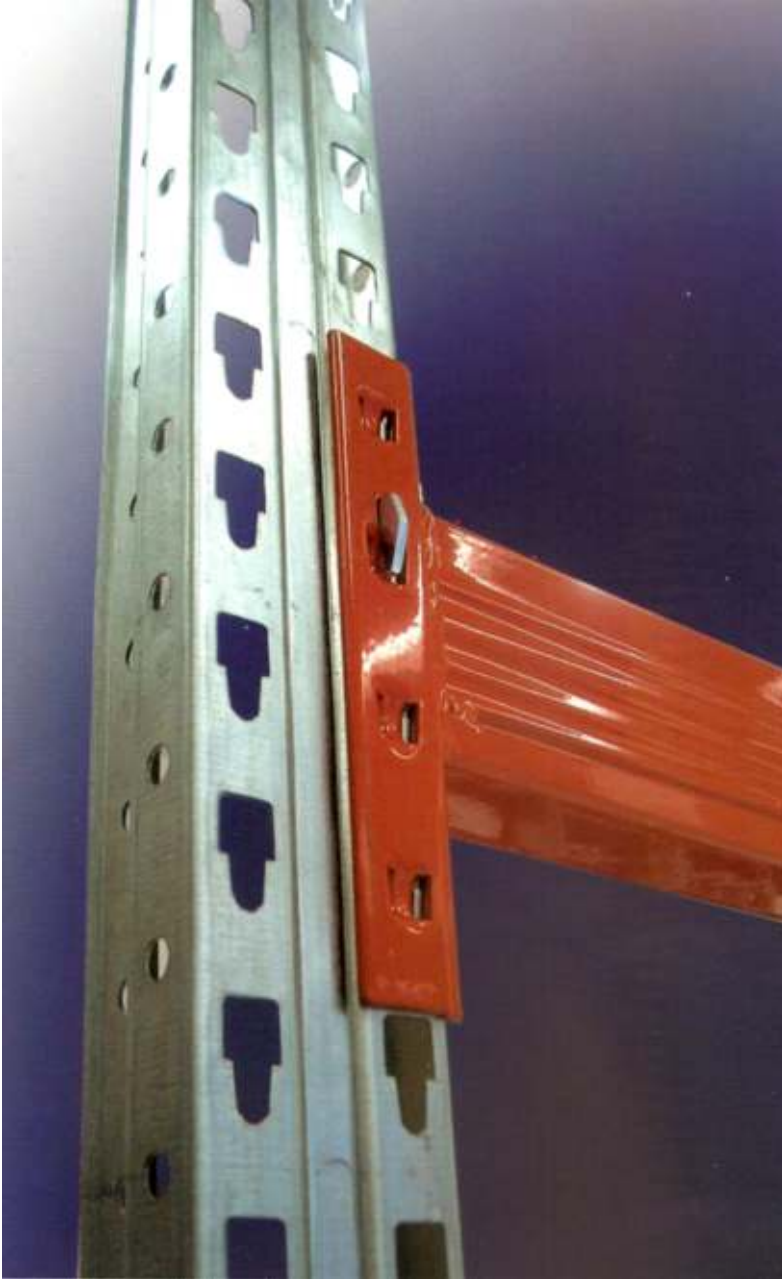

Seriya L80

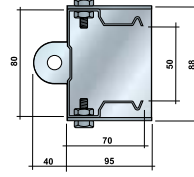

Seriya L100

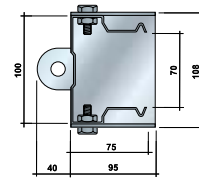

Seriya L120

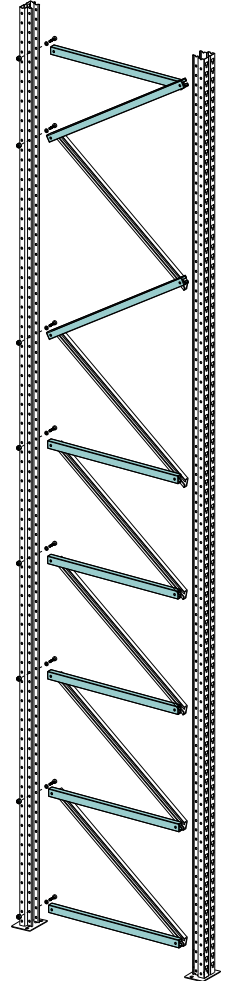
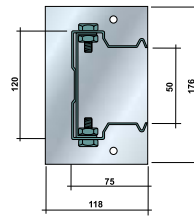

GREDE

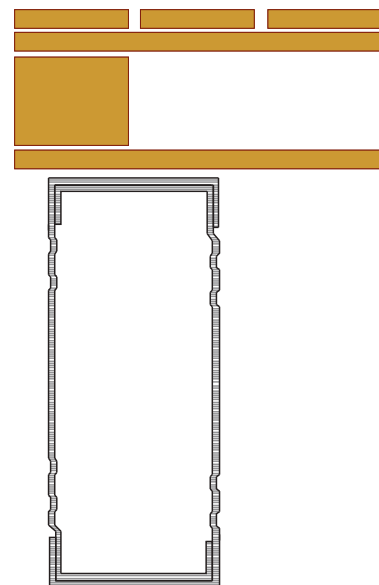
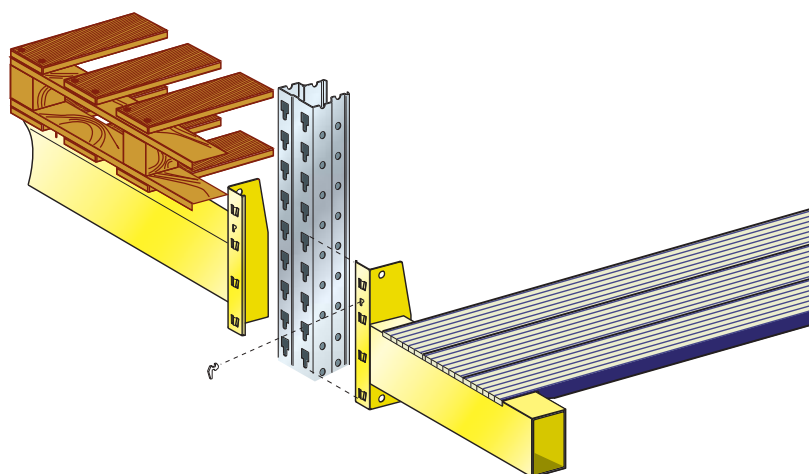

STANDARDNE GREDE SU DUŽINA 1209, 1809, 2209, 2709, 3009, 3309, 3609 mm

GREDE U PRESJEKU

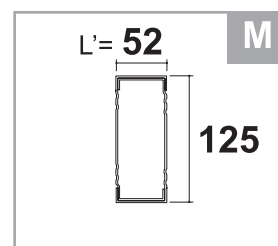
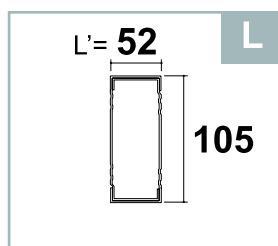
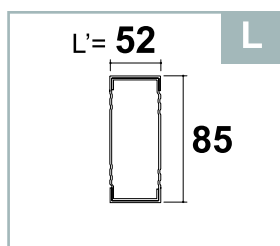

NOSIVOSTI PARA GREDA

| | |
|----------------|-------------------|
| 4000 - 10200Kg | ZA DUŽINU 1209 mm |
| 2750 - 6800Kg | ZA DUŽINU 1809 mm |
| 2000 - 5500Kg | ZA DUŽINU 2209 mm |
| 1400 - 4400Kg | ZA DUŽINU 2709 mm |
| 1150 - 3550Kg | ZA DUŽINU 3009 mm |
| 950 - 2950Kg | ZA DUŽINU 3309 mm |
| 800 - 2450Kg | ZA DUŽINU 3609 mm |

DODATNA OPREMA

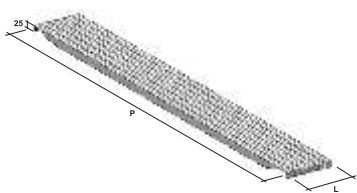

POCINČANE ISPUNE

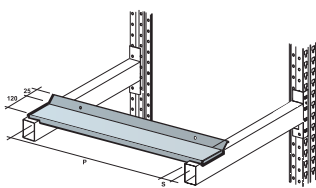

DRŽAČ KONTEJNERA

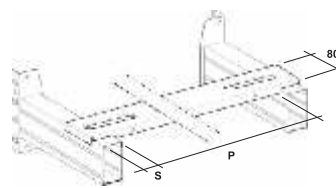

POPREČNA GREDA

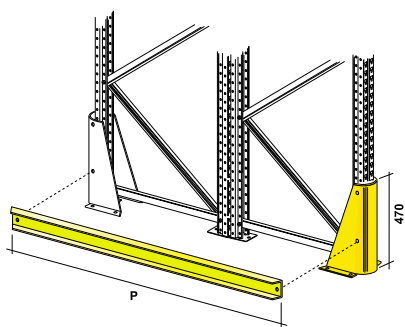

VERTIKALNI I HORIZONTALNI ŠTITNIK
STUPA BOČNE STRANE

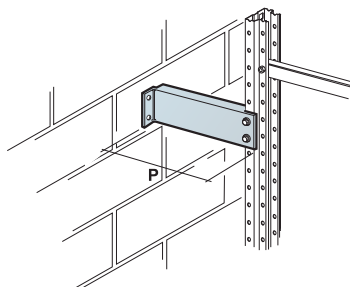

VEZA STUP ZID

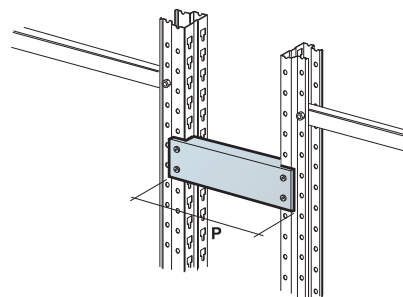

VEZA STUP STUP

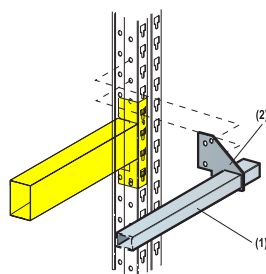

GRANIČNIK PALETE

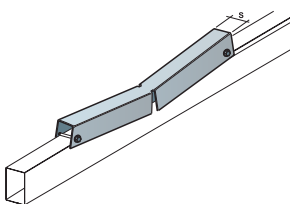

DRŽAČ BAČVI

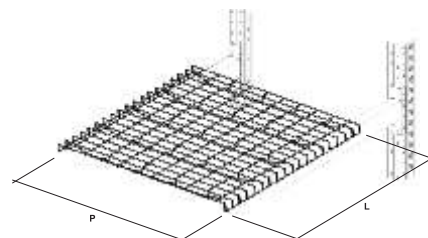

ŽIČANA ISPUNA

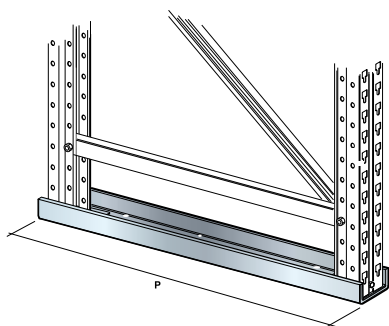

RAZDJELJIVAČ
OPTEREĆENJA

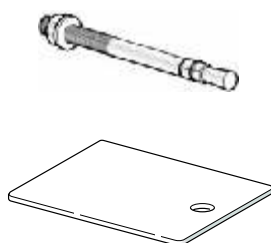

SIDRENA VEZA

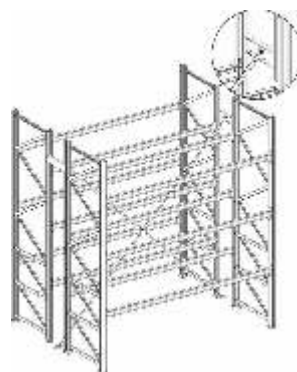

KRIŽNA UČVRŠĆENJA



TEHNIČKI PODACI

FOTO GALERIJA

